

# VoglFuge

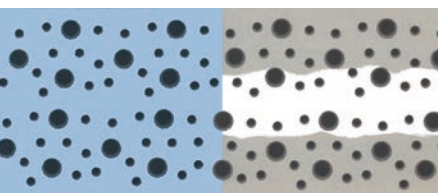

## Ceilings *Without Filler*

Create perfect acoustic design ceilings  
with the VoglFuge system

with air purification  
effect as a standard  
feature

## Ceilings without filler

Design acoustic ceilings meet the highest demands on performance and aesthetics for interior design. Particularly in highly frequented areas, such ceiling systems serve as sound absorbers, cooling elements and eye-catchers at the same time. For this reason, high precision in installation is particularly needed here. Unlike conventional ceiling solutions, errors in the installation are immediately visible in the finished product and seriously affect the final appearance.

This is where the VoglFuge system comes into play, allowing acoustic design ceilings to be implemented quickly, economically and with the utmost reliability during installation for guaranteed results.



### Benefits of the VoglFuge system:

The unique joint technology offers maximum reliability for installation and finishes:

- Quick mounting of panels – “edge-to-edge”
- No more complex panel alignment
- Quickest possible joint finishing with our unique VoglFuge-strip
- Significant time saving due to quick installation and drying times
- Maximum crack resistance
- Less dust and moisture
- Always complete with the VoglFuge System Kit including perforated panel screws SN 3.5 x 30 mm



The VoglFuge System Kit includes the required material, tools and a detailed assembly instruction to ensure the top quality of workmanship and result.

The right tools at the right time in exactly the right place.

Our VoglFuge System Kit is only available in combination with Vogl acoustic design panels. It cannot be purchased separately.

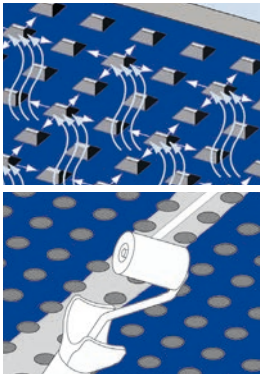

Vogl acoustic design ceilings of VoglFuge system are perforated ceiling panels with high acoustic performance and air purification effect (adsorption).

Black or white acoustic fleece backing (other fleece colours on request), four-side sharp-edged with undercut for installation using the quickest and most secure "edge-to-edge" laying principle.

Other available options: Acoustic design panels with non-perforated edges, block perforation, applications, manufacture in accordance with customer designs and ceiling plans.

Delivery includes VoglFuge System Kit (incl. perforated panel screws SN 3.5 x 30).

- Based on standard:** EN 14190 "Gypsum plasterboard products from reprocessing"  
**Fire rating:** A2-s1, d0 (non-flammable) according to EN 13501-1  
**Long edge:** SK (sharp-edged)  
**Short edge:** SK (sharp-edged)

with air purification effect as a standard feature



Illustration	Item number	Description	Details	m <sup>2</sup> /pallet Pcs./pallet
	LP-00256	Acoustic Design Panel VF 6/18R Acoustic fleece, black	1,188 x 1,998 x 12.5 mm	59.3 m <sup>2</sup>
	LP-00258	Acoustic Design Panel VF 6/18R Acoustic fleece, white	Perforated area: 8.7 % Mass: 9.1 kg/m <sup>2</sup>	25 pieces
	LP-00262	Acoustic Design Panel VF 8/18R Acoustic fleece, black	1,188 x 1,998 x 12.5 mm	59.3 m <sup>2</sup>
	LP-00264	Acoustic Design Panel VF 8/18R Acoustic fleece, white	Perforated area: 15.5 % Mass: 8.5 kg/m <sup>2</sup>	25 pieces
	LP-00268	Acoustic Design Panel VF 10/23R Acoustic fleece, black	1,196 x 2,001 x 12.5 mm	59.8 m <sup>2</sup>
	LP-00270	Acoustic Design Panel VF 10/23R Acoustic fleece, white	Perforated area: 14.8 % Mass: 8.5 kg/m <sup>2</sup>	25 pieces
	LP-00274	Acoustic Design Panel VF 12/25R Acoustic fleece, black	1,200 x 2,000 x 12.5 mm	60.0 m <sup>2</sup>
	LP-00276	Acoustic Design Panel VF 12/25R Acoustic fleece, white	Perforated area: 18.1 % Mass: 8.2 kg/m <sup>2</sup>	25 pieces
	LP-00280	Acoustic Design Panel VF 15/30R Acoustic fleece, black	1,200 x 1,980 x 12.5 mm	59.4 m <sup>2</sup>
	LP-00282	Acoustic Design Panel VF 15/30R Acoustic fleece, white	Perforated area: 19.6 % Mass: 8.0 kg/m <sup>2</sup>	25 pieces
	LP-00286	Acoustic Design Panel VF 8/12/50R Acoustic fleece, black	1,200 x 2,000 x 12.5 mm	60.0 m <sup>2</sup>
	LP-00288	Acoustic Design Panel VF 8/12/50R Acoustic fleece, white	Perforated area: 13.1 % Mass: 8.7 kg/m <sup>2</sup>	25 pieces
	LP-00292	Acoustic Design Panel VF 12/20/66R Acoustic fleece, black	1,188 x 1,980 x 12.5 mm	58.8 m <sup>2</sup>
	LP-00294	Acoustic Design Panel VF 12/20/66R Acoustic fleece, white	Perforated area: 19.6 % Mass: 8.0 kg/m <sup>2</sup>	25 pieces
	LP-00298	Acoustic Design Panel VF 8/18Q Acoustic fleece, black	1,188 x 1,998 x 12.5 mm	59.3 m <sup>2</sup>
	LP-00300	Acoustic Design Panel VF 8/18Q Acoustic fleece, white	Perforated area: 19.8 % Mass: 8.0 kg/m <sup>2</sup>	25 pieces
	LP-00304	Acoustic Design Panel VF 12/25Q Acoustic fleece, black	1,200 x 2,000 x 12.5 mm	60.0 m <sup>2</sup>
	LP-00306	Acoustic Design Panel VF 12/25Q Acoustic fleece, white	Perforated area: 23.0 % Mass: 7.7 kg/m <sup>2</sup>	25 pieces
	LP-00310	Acoustic Design Panel VF 8/15/20R Acoustic fleece, black	1,200 x 2,000 x 12.5 mm	60.0 m <sup>2</sup> *
	LP-00312	Acoustic Design Panel VF 8/15/20R Acoustic fleece, white	Perforated area: 9.5 % Mass: 9.1 kg/m <sup>2</sup>	25 pieces
	LP-00316	Acoustic Design Panel VF 12/20/35R Acoustic fleece, black	1,200 x 2,000 x 12.5 mm	60.0 m <sup>2</sup> *
	LP-00318	Acoustic Design Panel VF 12/20/35R Acoustic fleece, white	Perforated area: 11.0 % Mass: 8.9 kg/m <sup>2</sup>	25 pieces

\*Note: Despite being perforated irregularly, random perforation panels still yield a certain linear layout as the abutting panel edges must be non-perforated in any case. This is unavoidable and independent of the workmanship of the specialist contractor.

Block slotting										
Design	Slotting	Slots per "block"		Rim* (unslotted)		Slot area (panel)	Panel dimensions (standard size)		Centre distance (secondary profile)	Edges
		Short	Long	Short (mm)	Long (mm)	%	Width mm	Length mm	mm	
4F	5/82/15.4SL	69	4	73.9	73.3	15.7	1,200	2,400	300	SK
8F	5/82/15.4SL	30	4	73.9	73.3	13.7	1,200	2,400	300	SK
8/16F	5/82/15.4SL	4 x 6	4	73.9	73.3	10.9	1,200	2,400	300	SK

\*Edge dimensions refer to visible rim

Block perforation										
Design	Perforation	Holes per "block"		Rim* (non-perforated)		Perforated area (panel)	Panel dimensions (standard size)		Centre distance (secondary profile)	Edges
		Short	Long	Short (mm)	Long (mm)	%	Width mm	Length mm	mm	
4F	8/18R	64	30	41	41	12.9	1,224	2,448	312.5	SK
	12/25R	45	21	44	44	14.9	1,200	2,400	300	SK
	12/25Q	45	21	44	44	18.9	1,200	2,400	300	SK
8F	8/18R	30	30	41	41	12.1	1,224	2,448	312.5	SK
	12/25R	21	21	44	44	13.9	1,200	2,400	300	SK
	12/25Q	21	21	44	44	17.7	1,200	2,400	300	SK
32F	8/18R	13	13	41	41	9.1	1,224	2,448	312.5	SK
	12/25R	9	9	44	44	10.2	1,200	2,400	300	SK
	12/25Q	9	9	44	44	13.0	1,200	2,400	300	SK

\*Edge dimensions refer to visible rim

Diagrams represent visible side

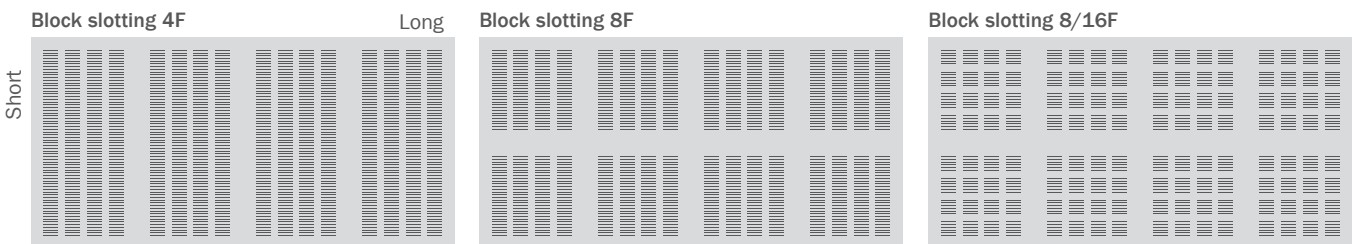

Slotting only possible in longitudinal direction of the ceiling panels.

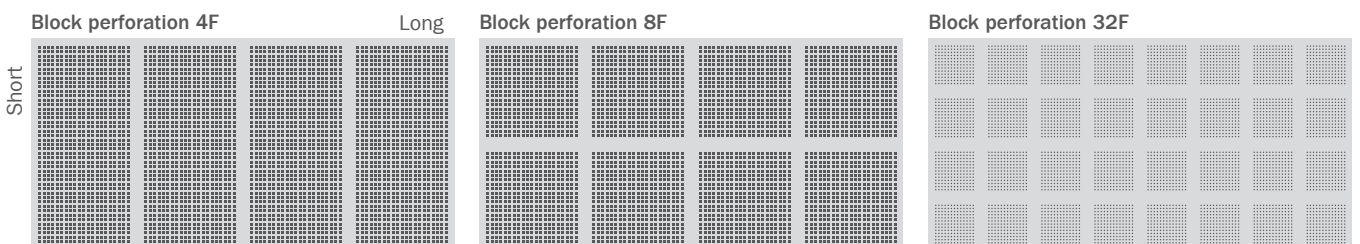

Example: 12/25Q

Example: 12/25Q

Example: 8/18R

VoglFuge panels with non-perforated edges

1 rim non-perforated

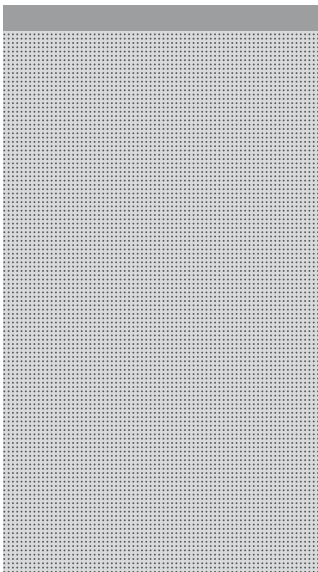

2 rims non-perforated

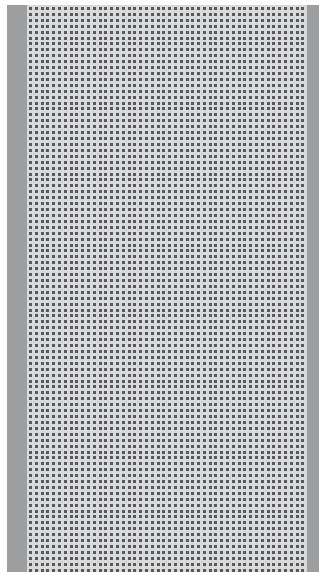

3 rims non-perforated

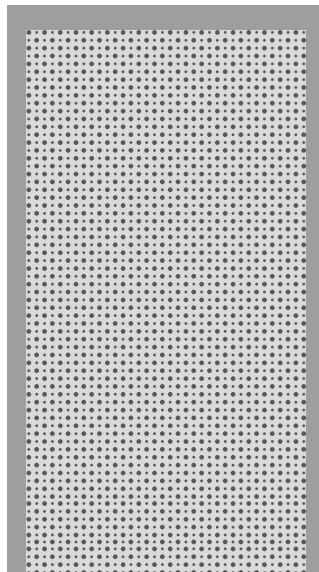

4 rims non-perforated

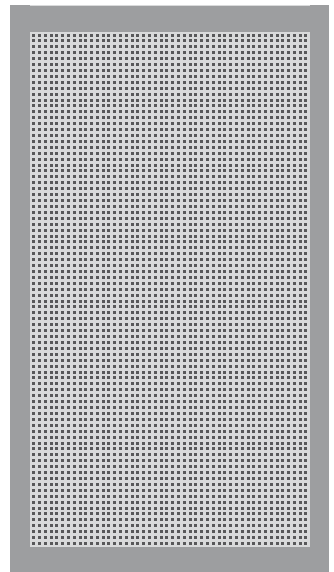

VoglFuge panels with moulded components attached

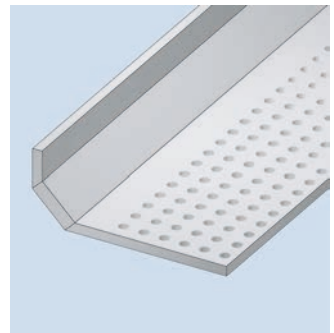
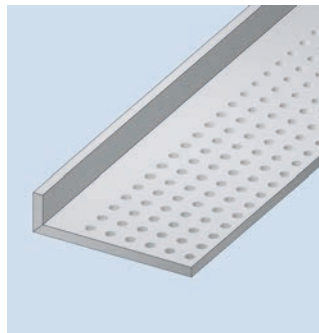
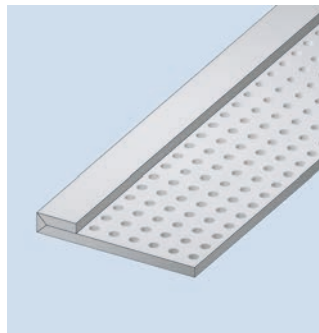
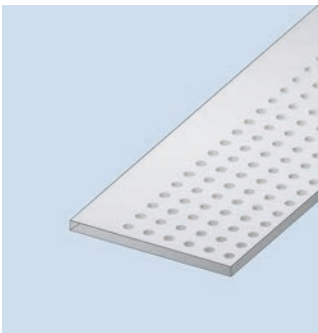

VoglFuge panels according to layout plan

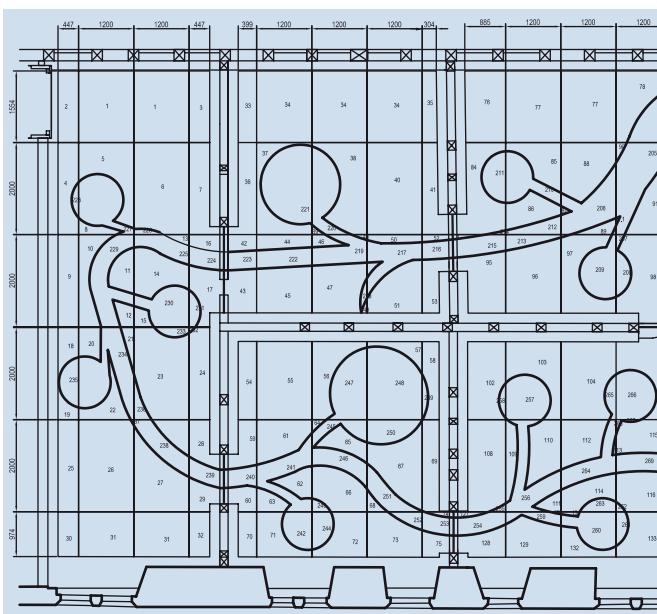

**You want a ceiling that features not only high acoustic performance, but also outstanding appearance?**

We are glad to assist you! Our experts can adapt our acoustic design panels exactly to your desired ceiling surface. When manufacturing ceiling systems to plan, we supply the custom-made and perfectly fitted acoustic design panels as well as a layout plan for use on the job site, thus ensuring reliable results for the installation. And of course, our moulded components, stretch ceilings and ceiling components can be perfectly integrated into your planned ceiling surface.



The primary profiles are hung from the structural soffit with suspended brackets using fixing materials approved by the relevant building authorities.

The centre distance and number of suspended brackets, as well as the fixation, are subject to site requirements and EN 13964/DIN 18181. The CD 60/27 secondary profiles are attached to the CD 60/27 primary profiles using cross connectors.

CD 60/27 are extended using straight connectors. For primary grid profiles, always ensure that the joint is close to a suspended bracket (max. 100 mm). Joints should generally be staggered.

The plasterboards should be installed in accordance with EN 13964/DIN 18181 and the manufacturer's guidelines.

Additional items such as lighting, ventilation, sprinkler systems etc. must be individually suspended.

Any changes in the framework owing to integrated ceiling components must be considered.

Block perforations and block slotting require different secondary profile centre distances which are shown in our tables on page 62.

VoglFuge framework								
Technical data	Unit	Perforated panel ceiling						
Panel thickness	mm	12.5						
Distributed load	kN/m <sup>2</sup>	≤ 0.15					≤ 0.30	
Centre distance of suspended bracket A	mm	1,150	1,050	1,000	950	900	900	750
Centre distance of primary profiles X	mm	600	800	900	1,000	1,100	600	1,000
Centre distance of secondary profiles Y	mm	see table below						

Item	Unit	Centre distance of secondary profiles Y
Acoustic Design Panel 6/18; 8/18; 8/18Q; 10/23; 12/25; 12/25Q; 8/12/50; 8/15/20; 12/20/35	mm	333
Acoustic Design Panel 15/30 12/20/66	mm	330

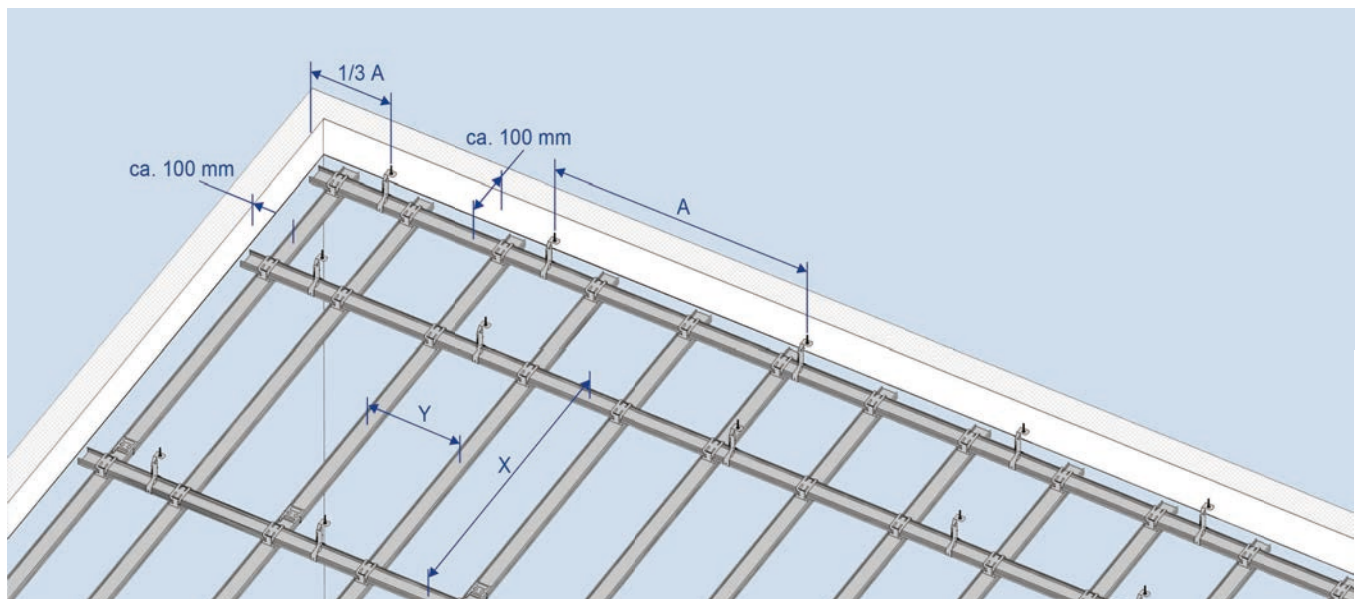

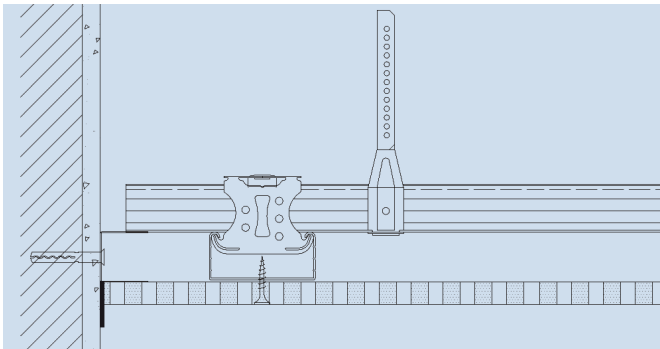

**Wall connection with filled joint:**

For filled wall connections, a double layer fleece strip is used to separate the acoustic ceiling from the wall.

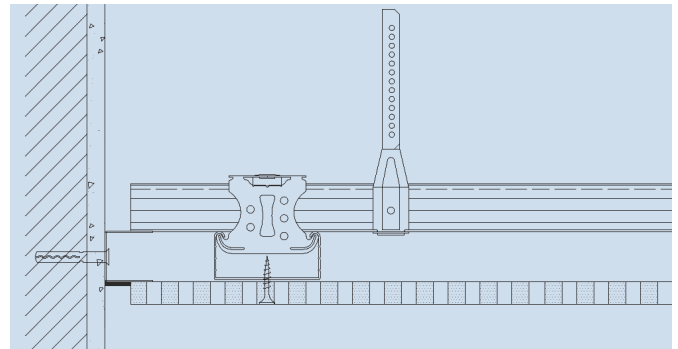

**Wall connection – shadow gap:**

For wall connections with a shadow gap, the panel is only installed up to the UD profile as this may be covered with a strip of adhesive double layer fleece in order to colour the shadow gap.

Please contact us if you require additional technical details on possible wall connections.

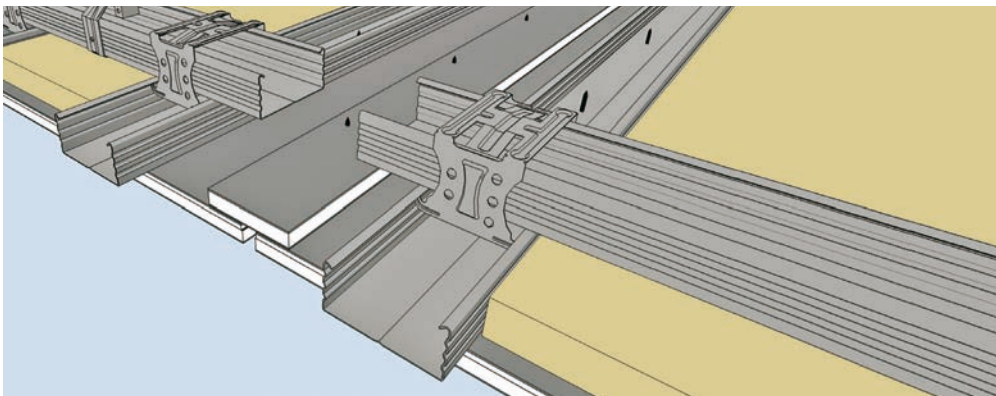

**Expansion joints:**

To reduce the risk of cracking in the ceiling, expansion joints should be installed every 10 linear metres/100 m<sup>2</sup> of ceiling area.

The framework must be completely severed (see illustration) and the panel strips above the joint must be screwed down on one side only.

Tip: The panel strip may be covered with adhesive double layer fleece on the visible side if colouring the expansion joint in either black or white is desired.

Material required per m<sup>2</sup> based on a ceiling of 100 m<sup>2</sup> (10 m x 10 m, without loss or waste)

Metal framework, suspended bracket centre distance 1,000 mm, primary profile spacing 900 mm, secondary profile spacing 333 mm

Item number	Item description	Unit	Quantity
<b>Fixation</b>			
Standard	Safety nail, DN 6 x 35	piece	1.3
<b>Suspended brackets</b>			
See product range	Direct suspended bracket 50/120/200 and	piece	1.3
100994	Tapping screw LN 3.5 x 9.5	piece	2.6
or			
See product range	Vernier hanger / vernier bottom part and	piece	1.3
100981	Vernier security pin and	piece	1.3
See product range	Vernier top part, 200 - 2,000 mm, custom lengths on request	piece	1.3
<b>Profiles and connectors</b>			
See product range	CD profile 60/27/0.6 rK, l=XXX mm	m	4.1
PRO-00106	UD profile 28/27/0.6, 3,000 mm	m	0.4
101595	Connector, lengthwise, CD 60/27	piece	0.8
101567	Cross connector, CD 60/27	piece	3.3
100995	Perforated panel screw SN 3.5 x 30	piece	22

Check ceiling framework for rigidity and evenness (using a straight-edge).



Then check ceiling grid CD sections for centre distances and adjust, if necessary. Always mount straight connectors in a staggered manner (see figure). Measure centre distances accurately!

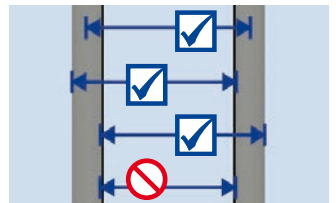
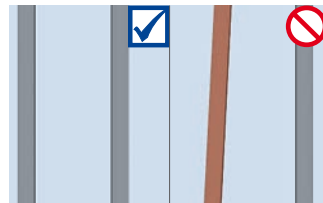
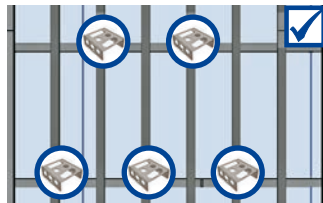

As viewed from entrance area, choose panel arrangement with short edges parallel to windows (main direction of light).



**We recommend the following accessories for installation:**

Perforated panel screws, including screw bit

**Correct handling of ceiling panels:**

- Always take into account the load carrying capacity of the building when storing ceiling panels
- Do not store ceiling panels upright, but always flat on panel pallets
- Always carry ceiling panels with short edges upright
- Protect ceiling panels from moisture; relative humidity should be 40 - 80 %
- Avoid major temperature fluctuations
- Do not expose stored ceiling panels to direct sunlight

Locate centre of room to position first ceiling panel, also taking into account resulting ceiling perimeter to wall connections.



Get panel to correct position on framework using a panel lifter if working alone, or else another worker's help.



Perforation pattern	Centre distance
Straight round perforation 6/18, 8/18, 10/23, 12/25 Offset round perforation 8/12/50, Straight square perforation 8/18, 12/25, Random perforation 8/15/20, 12/20/35	333 mm
Straight round perforation 15/30 Offset round perforation 12/20/66	330 mm

Screws must be put into panel at right angles and countersunk head screwed down to 0.5 mm below visible surface of ceiling panel.

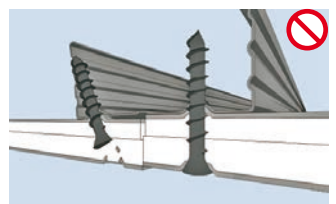
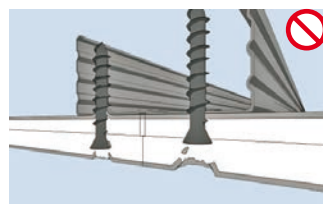
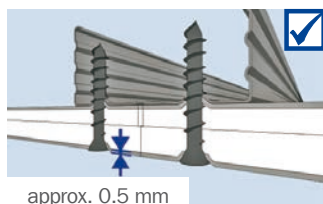

Screws should be spaced 170 mm at max. from fixing point to fixing point. Distance between screw and panel edge not to exceed 26 mm. Avoid damaging acoustic design panels by countersunk heads.

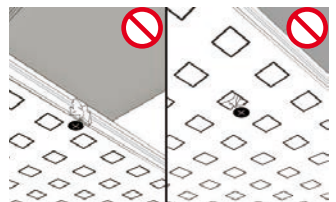
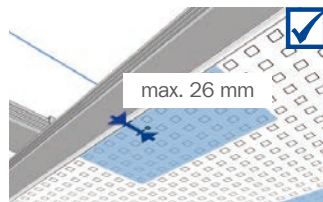
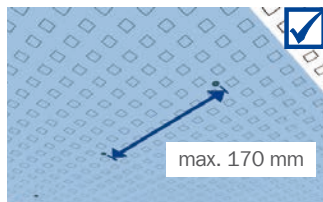

First, screw ceiling panel to framework in centre of panel, then lower panel lifter and fix a screw in centre of each short edge before finally screwing down long edges.

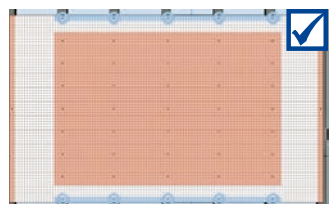
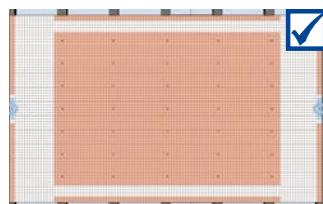



Take note of panel labelling (stamp) and mount in direction of reading (all stamps should point in same direction).



Use CD profile or straightedge as end stop. Position next panel by sliding it to first alongside CD profile / straightedge and fix in place.



**General site conditions / Manufacturer's instructions:**

- Take movement joints of building structure into account
- Plan to include expansion joints after approx. every 10 m or approx. 100 m<sup>2</sup>
- Cardboard layer must not be penetrated by screws, but merely displaced downwards
- Working temperature should be at least +10 °C and job site temperature not below +5 °C
- Place any damping (mineral wool layer) directly onto the ceiling panels
- Carry out any additional work on ceiling (access openings, lighting recesses) immediately after installing ceiling panels and always before finishing joints

Fix screws in panel joint area using alternating pairs across panels ("zig-zag" principle), starting left or right next to screw which has already been fixed. This will create flush joint areas.

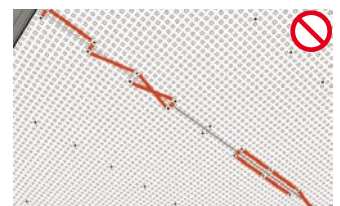
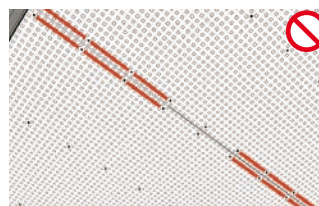
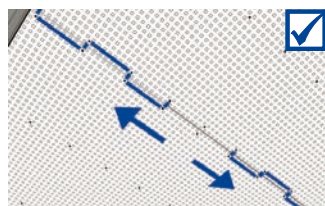

Install ceiling panels first lengthways, then crossways, resulting in cross arrangement on ceiling. Cover remaining areas in same manner, working from centre of room outwards.

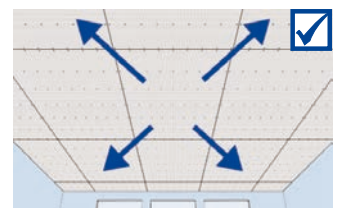
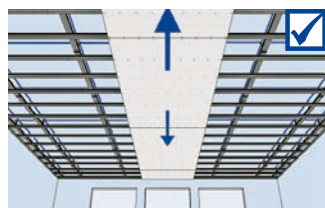

Lay remaining ceiling panels edge-to-edge, always checking that joints are level and using "cross joint" system only.

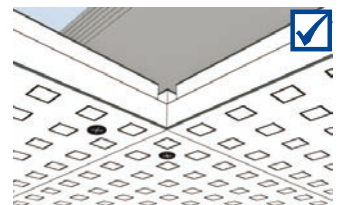
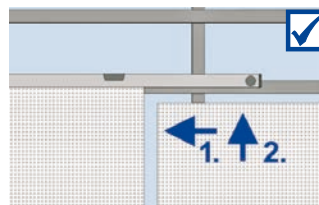
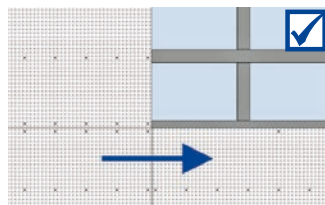

After all panels have been installed, recheck that all joints are level and adjust, if necessary, using a screwdriver. Then check with a straightedge.

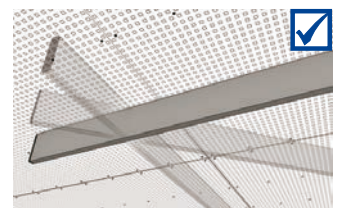
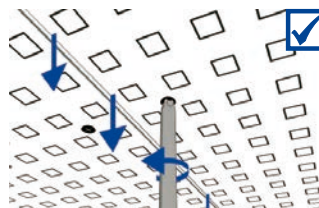
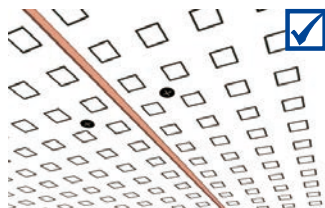

Place any damping layer directly onto back of ceiling panels.

Never screw into UD28 profile when mounting panels at ceiling perimeter.

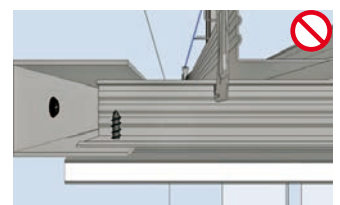
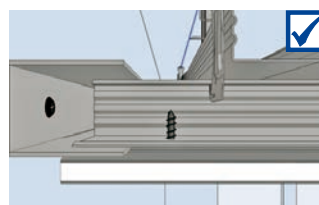
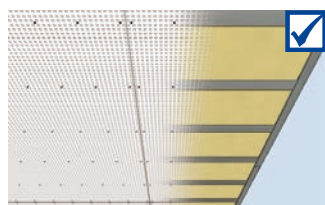

Provide for expansion joint of 5 to 10 mm every 10 linear metres / 100 m<sup>2</sup>. Additional board strip above joint must be screwed down on one side only.

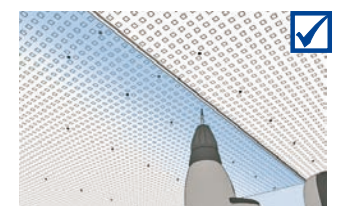
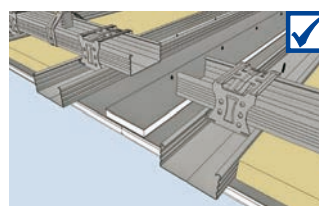
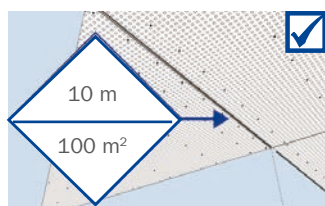

**Important!** All work that could result in damage to the ceiling surface must be completed before commencing jointing.

Check ceiling! Level out any height discrepancies in the panel joint areas using a screwdriver, if necessary repair any chips or damage to the plasterboard. Then spot fill screw heads in joint areas.

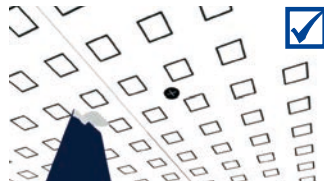

**Voglfuge System Kit contents:**

Vogl liquid glue, strip dispenser incl. 8 mm strip, sponge, mixing stick, roller grid, lambskin roller, abrasive mesh, sanding paper, Vogl screw head and repair filler, Japan spatula, perforated panel screws incl. bit

Use abrasive mesh to remove any protruding pieces of plasterboard in the joint area. Only sand in direction of joint.

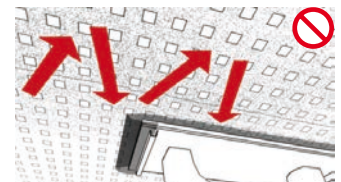
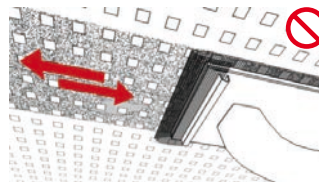
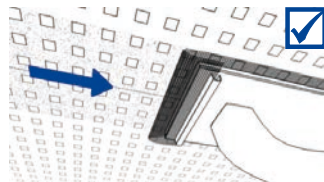

Slightly dampen joint area using a sponge, but avoid excessive wetting of acoustic design panels.

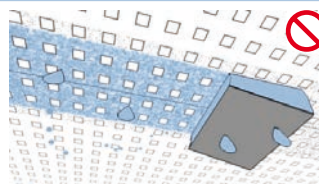
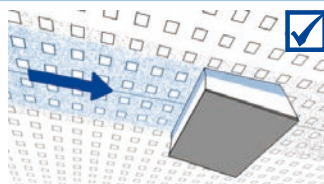

Ensure liquid joint coating is evenly distributed on lambskin roller by rolling downwards over roller grid supplied.



Vogl Liquid joint coating = ready mix

**General site conditions / Manufacturer's instructions:**

- Only store liquid joint coating in a \*\* frost free environment \*\*
- Close liquid joint coating containers securely during long breaks
- Stir liquid joint coating well before use!
- Working temperature should be at least +10 °C and job site temperature not below +5 °C
- Avoid sudden heating and cooling of rooms
- Relative humidity: 40 - 80 %
- Ceiling framework must be installed level and be adequately rigid
- Self-levelling, cement or asphalt screeds must be fully dried – no residual moisture
- Jointing strips must only be applied "edge-to-edge", i.e. no overlapping

Apply liquid joint coating using lambskin roller. Fine texture of lambskin roller must be visible.

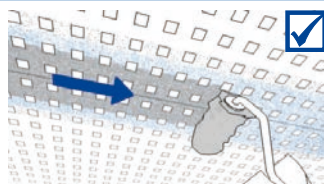

Fix strip with rubber side facing panel in middle of joint already wet with liquid coating. Using your left thumb press on the strip until the coating comes out from both sides of the strip, bringing your left thumb along the strip to meet your right thumb. Follow the same procedure for the next joint.

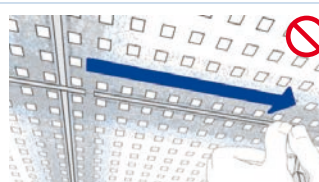

Subsequently coat joint area generously with liquid joint coating and roll lambskin roller over joint, applying slight pressure. Texture of lambskin roller must be clearly visible.

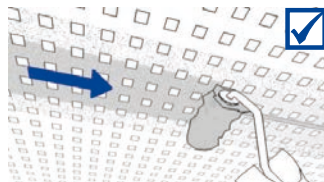

System's drying time: 12 h

**Surface treatment for painters**

(in accordance with ATV painting work DIN 18363):

- Only apply coating by roller; spray application is not permitted!
- Prior to application of paint coat, a primer should generally be applied in accordance with manufacturer's specifications
- The manufacturer's recommended drying times for both primer and finishing coat must be strictly observed
- Alkaline coatings are unsuitable for plasterboards
- 3 coats of paint must be applied (1 prime coat + 2 finishing coats), and recommended drying times adhered to
- System manufacturer's technical data sheets for primers and finishing coats must be observed

While joints are drying use time to fill remaining screw heads in panel centres using screw head and repair filler.

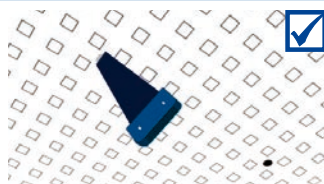

Once the joints have fully dried, gently sand the texture left by the lambskin roller using the sanding paper. Only sand in the direction of the joint: Do not cross sand!

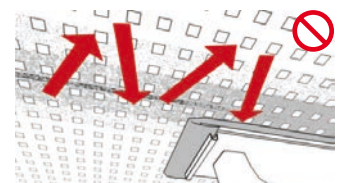
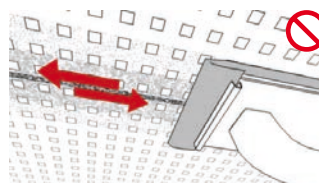
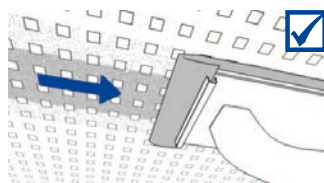

**Acoustic Design Panels**  
 (with air purification effect) – VoglFuge system

Suspended ceiling structure, one side clad with Vogl acoustic design panels backed with sound absorbing fleece, mounted to a rigid ceiling framework of galvanised metal profiles, hung with flush and horizontally aligned suspended brackets and installed using fixing materials approved by the building authorities, installation in accordance with manufacturer's instructions, including all connection and jointing work as well as connection and fixing materials.

**System structure**

Framework in accordance with DIN 18181:2007-02

**Profiles:**

Pressure-resistant design made from galvanised sheet steel profiles CD 60/27 as primary and secondary profiles in accordance with EN 14195

**Suspended brackets:**

- Suspend with vernier systems (top part, vernier hanger)\*
- Suspend with vernier systems (top / bottom part)\*
- Suspend with direct suspended brackets\*
- Use fixing materials approved by the relevant building authorities.

**Connection:**

For primary-secondary profile connection with cross connectors, use suspended brackets and cross connectors in accordance with EN 13964.

Suspended bracket centre distance: max. 900 mm,  
 Primary profile centre distance: max. 1,100 mm,  
 Secondary profile centre distance: 250/330/333 mm\*

**Covering:**

Vogl acoustic design panels are perforated ceiling panels in accordance with EN 14190, with air purification effect, one layer 12.5 mm, laid edge-to-edge and fixed to the framework using perforated panel screws SN 30, with screw spacing max. 170 mm.

**Perforation pattern / perforated area / mass per unit area:**

- 6/18 round / 8.7 % / 9.1 kg/m<sup>2</sup>\*
- 8/18 round / 15.5 % / 8.5 kg/m<sup>2</sup>\*
- 10/23 round / 14.8 % / 8.5 kg/m<sup>2</sup>\*
- 12/25 round / 18.1 % / 8.2 kg/m<sup>2</sup>\*
- 15/30 round / 19.6 % / 8.0 kg/m<sup>2</sup>\*
- 8/12/50 round / 13.1 % / 8.7 kg/m<sup>2</sup>\*
- 12/20/66 round / 19.6 % / 8.0 kg/m<sup>2</sup>\*
- 8/18 square / 19.8 % / 8.0 kg/m<sup>2</sup>\*
- 12/25 square / 23.0 % / 7.7 kg/m<sup>2</sup>\*
- 8/15/20 round / 9.5 % / 9.1 kg/m<sup>2</sup>\*
- 12/20/35 round / 11.0 % / 8.9 kg/m<sup>2</sup>\*

**Distributed load:**

- less than or equal to 0.15 kN/m<sup>2</sup>\*
- less than or equal to 0.30 kN/m<sup>2</sup>\*

**Fleece backing:**

Panels backed with sound absorbing fleece as:

- acoustic fleece, black\*
- acoustic fleece, white\*

**Joint finishing / filling:**

Fill screw heads using Vogl screw head and repair filler flush with surface. Carry out joint finishing using VoglFuge system in accordance with manufacturer's instructions.

**Subbase:**

- Suspension height: h = mm
- Installation height: h = mm
- Room height: h = mm
- Insulation thickness: th = mm

Complete system: Vogl Deckensysteme, or equivalent

\* Delete as applicable



Errors, printing faults and technical changes reserved. Consumption, quantity and design details are based on empirical values. The details contained in this text correspond to the current state of technology. Any relevant valid building technology regulations, standards and guidelines must be observed in addition to our processing instructions. All rights reserved. Reprints as well as electronic reproduction, even extracts, require the express approval of Vogl Deckensysteme GmbH, Industriestrasse 10, DE-91448 Emskirchen, Germany.

**PICTURE CREDITS**

Page 1 photo: Donal Murphy · Page 2 right picture column, 1st from top, photo: Donal Murphy · Page 2 right picture column, 2nd from top, photo: Karl Thomas · Page 2: centre left, photo: Vogl Deckensysteme GmbH · Page 2: centre right, photo: Angelo Kaunat · Page 2: bottom, photo: Vogl Deckensysteme GmbH  
 Page 5 photo: Thilo Jaeckel · Page 11 photo: Walter Henisch · Page 12: Rentex Wand- und Deckensysteme GmbH, photo: Damian Zimmermann

Status 11/2018



**Vogl Deckensysteme GmbH**

Industriestrasse 10  
DE-91448 Emskirchen

Phone +49 9104 825-0  
Fax +49 9104 825-250

info@vogl-ceilingssystems.com  
www.vogl-ceilingssystems.com

